

SCHWINGMETALL® Parabelfedern

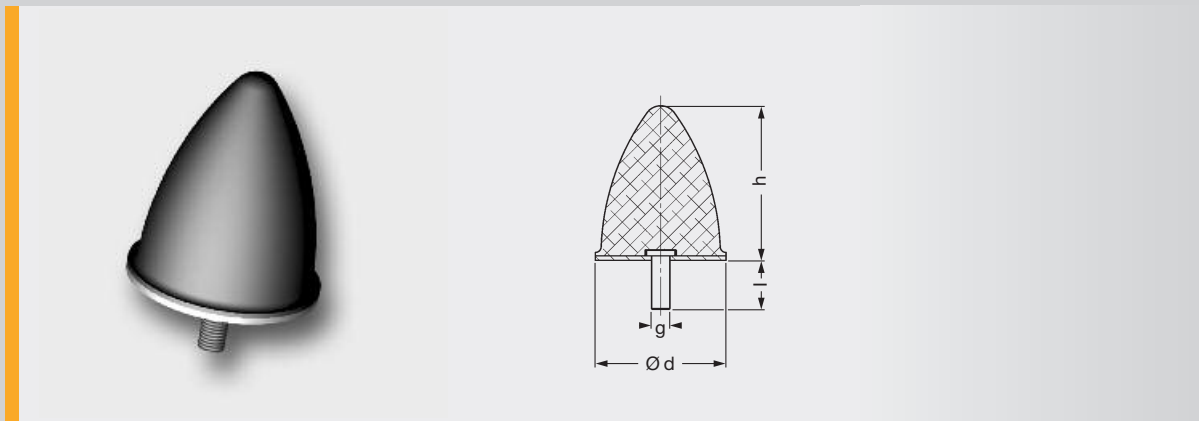

Parabelfedern									
Abmessungen				max. Belastungen		Masse Stück [kg]	Elastomer Härte [Shore A]	Form-Nr.	Artikel-Nr.
d [mm]	h [mm]	l [mm]	g	F _z [N]	W [N/mm]				
21	24	19,0	M6	529	2,4	0,011	55	58496	3915236000
32	36	20,5	M8	1398	8,0	0,032	55	58495	3915235000
52	58	28,0	M10	3863	37,0	0,110	55	58497	3915237000
75	89	37,0	M12	8524	120,0	0,345	55	58498	3915238000
115	136	43,0	M16	17122	412,0	1,200	55	58102	3915234000
165	195	43,0	M16	36228	1200,0	3,000	55	58499	3915239000

Belastungsrichtung



Kraft- und Energie-Weg-Diagramme



Form-Nr. 58496

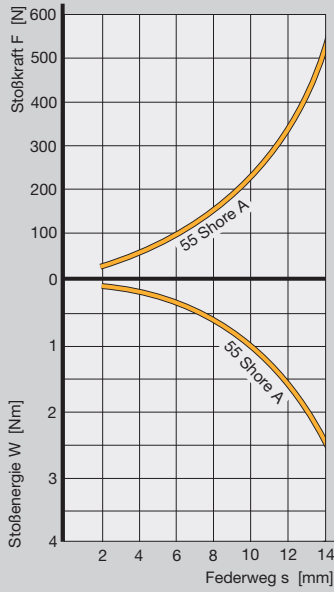

Form-Nr. 58495

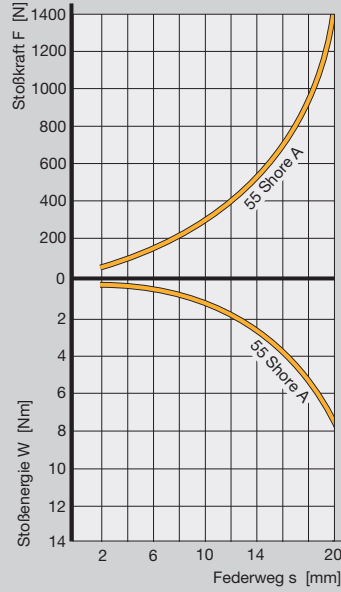

Form-Nr. 58497

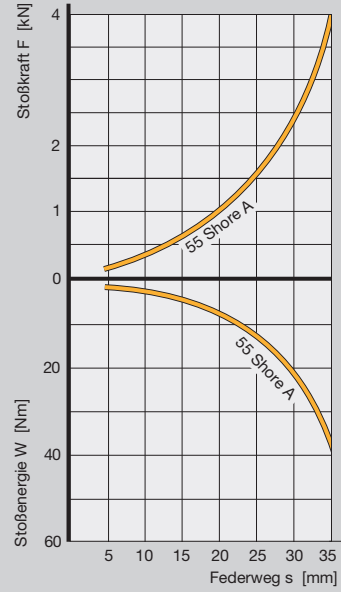

Form-Nr. 58498

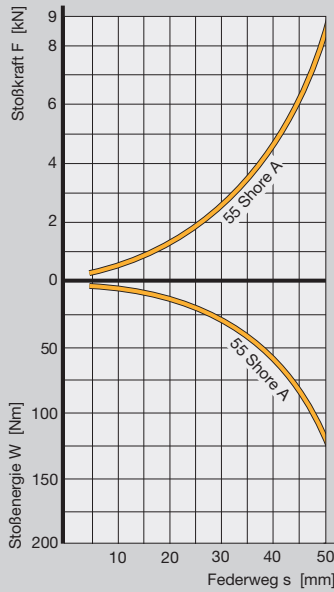

Form-Nr. 58102

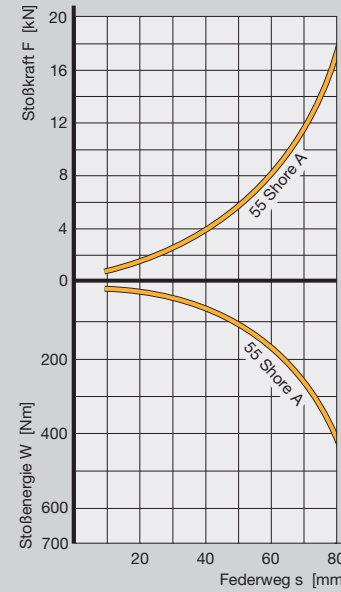

Form-Nr. 58499

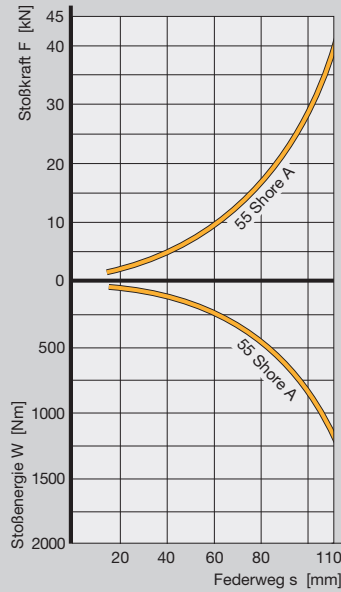

Anschläge