



EluFlex® 90-300 SB Datenblatt



Stand Status: 07/07/2020

Technische Spezifikationen Technical specifications

Artikelnummer Article number

920104

Werkstoffe Materials

- | | |
|--|--|
| <p>Metalle:</p> <ul style="list-style-type: none"> ■ Aluminiumlegierung AlMgSi1 (EN AW-6082) blau eloxiert ■ sehr korrosionsbeständig (1.000 Stunden Salzsprühnebeltest nach DIN EN 9227 AASS) <p>Elastomer:</p> <ul style="list-style-type: none"> ■ NR (Naturkautschuk) <p>Eigenschaften siehe Datenblatt „Werkstoffeigenschaften Gummi“ auf www.sd-dresden.de</p> | <p>Metals:</p> <ul style="list-style-type: none"> ■ Aluminium alloy AlMgSi1 (EN AW-6082) blue anodised ■ highly corrosion-resistant (1,000 hours salt spray test according to DIN EN 9227 AASS) <p>Elastomer:</p> <ul style="list-style-type: none"> ■ NR (natural rubber) <p>For characteristics see „Rubber material characteristics“ on www.sd-dresden.de</p> |
|--|--|

Technische Zeichnung Technical drawing

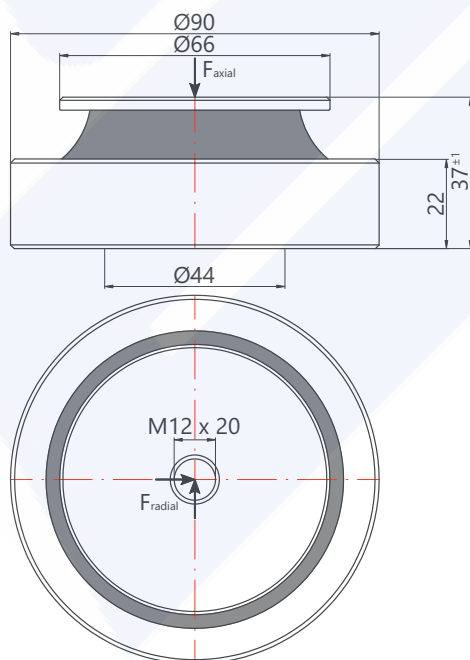

Die Angaben für Federeigenschaften und Eigenfrequenzverlauf sind Anhaltswerte und können aufgrund der Fertigungstoleranz der Elastomere etwas abweichen.
The information provided in relation to spring characteristics and the resonant frequency course constitutes reference values and may deviate slightly, depending on the production tolerance of the elastomer.

Federeigenschaften Spring characteristics

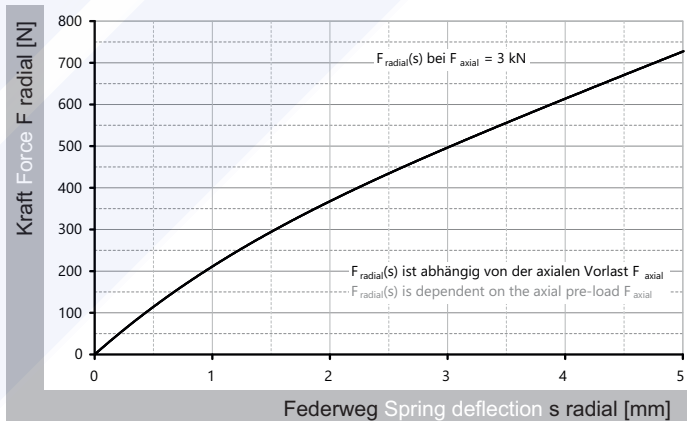
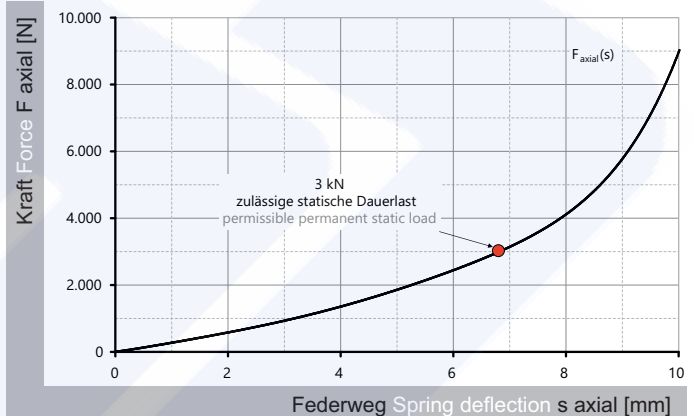

Verlauf der Eigenfrequenz Course of resonant frequency

