

SCHWINGMETALL® Torsionselemente

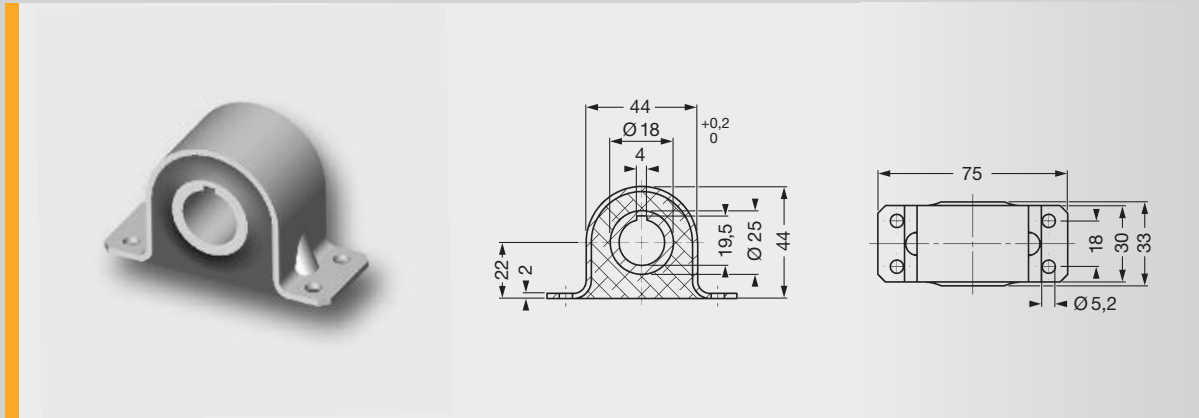

Form-Nr. 31510

Federsteifigkeiten			max. Belastungen			Masse Stück [kg]	Elastomer Härte [Shore A]	Form-Nr.	Artikel-Nr.
C_x [N/mm]	C_y [N/mm]	C_z [N/mm]	F_x [N]	F_y [N]	F_z [N]				
800	152	800	850	750	850	0,153	40	31510	3936401001
1413	267	1413	1100	1100	1100	0,153	55	31510	3936201001
2187	400	2187	1150	1300	1150	0,153	65	31510	3936101001
1259	189	1259	1500	1100	1500	0,423	40	31700	3936402001
2267	344	2267	2200	1900	2200	0,423	55	31700	3936202001
3378	567	3378	2800	2200	2800	0,423	65	31700	3936102001

► Hauptbelastungsrichtung Radial, statische axiale Lasten unzulässig

Kennlinien Form-Nr. 31510

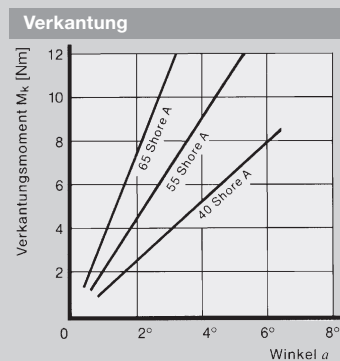
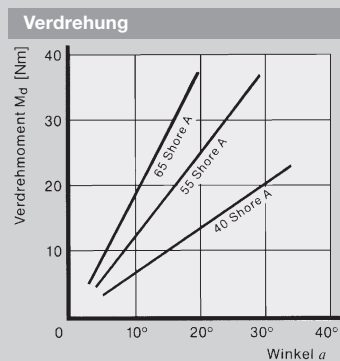
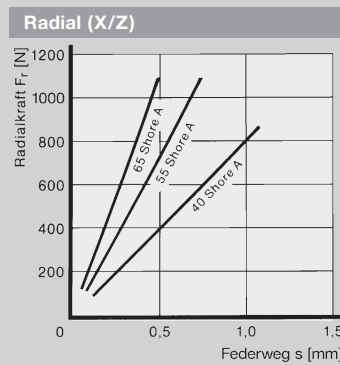
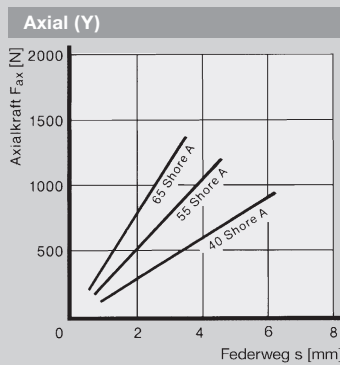

Belastungsrichtungen

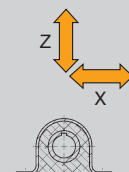

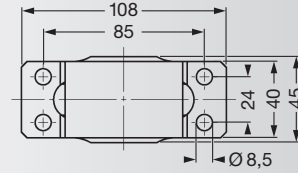
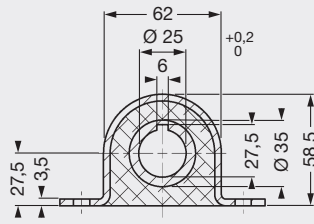

Form-Nr. 31700

Kennlinien Form-Nr. 31700

Axial (Y)

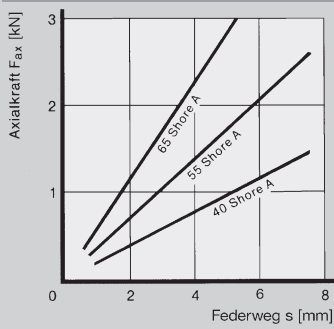

Radial (X/Z)

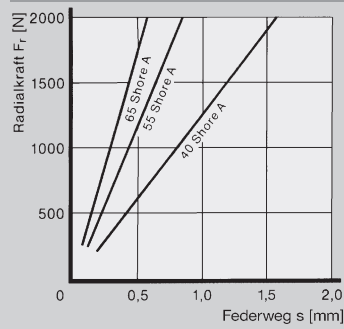

Verdrehung

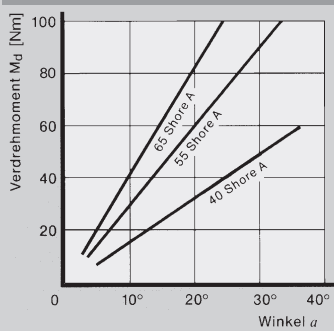

Verkantung

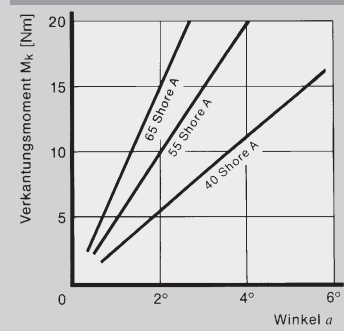

Belastungsrichtungen

